



Light commercial vehicle

RENAULT TRUCKS TRAFIC

[renault-trucks.com](https://www.renault-trucks.com)



**RENAULT
TRUCKS**

Take the road with Renault Trucks

Driving with Renault Trucks means choosing a partner committed to support you, whenever you need it.

It means being able to select the most effective and technical solution. It means being able to choose trucks that are functional, efficient and comfortable.

It also means choosing easy to use, tried and tested technologies that are right for your business.

It involves building a strong, warm and lasting partnership.

It means making the right choice.



→ Pioneers since 1894

Marius Berliet designed his first engine back in 1894. Louis Renault founded the Renault Frères company in 1898. With this heritage of excellence in the production of trucks in France, Renault Trucks is carrying on a long tradition of expertise and innovation that saw the appearance of the first electric truck in 1923 and the flat platform cab in 1990. We put businesses on the road to high performance.

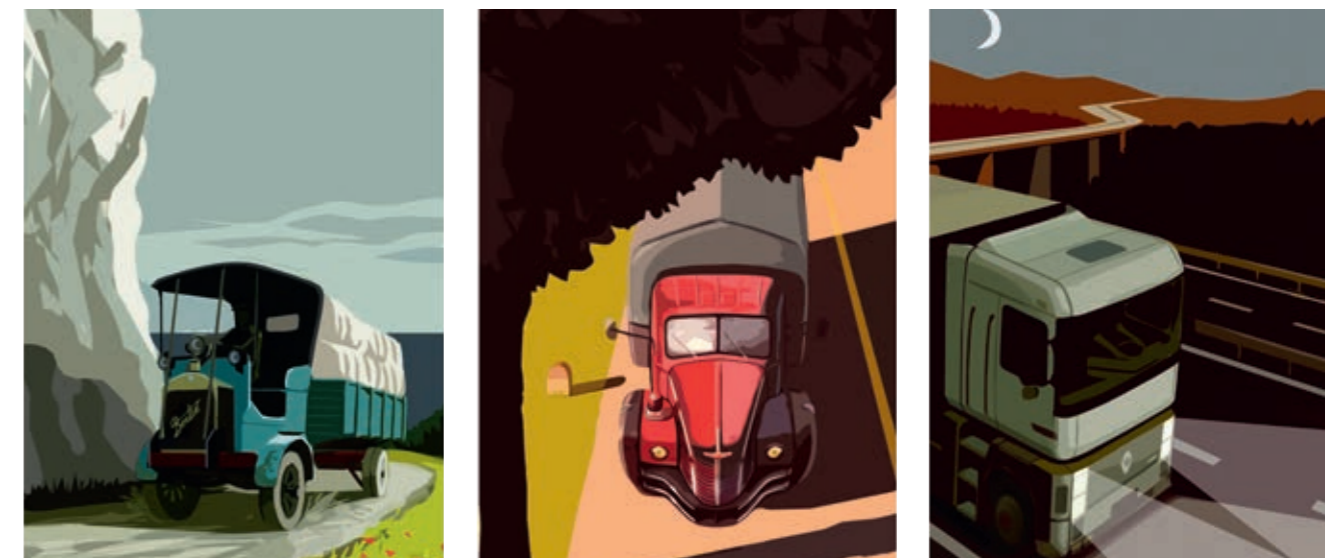

→ Committed to the future



We can provide the right transport solution at the right time with the right energy solution, with minimal environmental impact. Renault Trucks provides solutions to efficiently reduce pollution and CO₂ emissions: optimised diesel engines and biofuels, 100% electric trucks as well as a range of services promoting strong environmental performance.

→ Responsible manufacturer

As a member to the UN Global Compact, Renault Trucks is committed to reducing its impact on our climate and to using resources and conducting business in a responsible manner. Renault Trucks has had its social responsibility audited by the independent Ecovadis organisation, which has ranked it among the best performing companies in its sector.



Renault Trucks Traffic Red EDITION

only in our network

For more than 35 years, Renault Trucks has supported business by putting its heavy truck expertise at the service of professionals that drive commercial vehicles.

Explore the Renault Trucks Traffic Red EDITION, available on both Diesel and electric versions, which puts the finishing touches to Renault Trucks' range of commercial vehicles.

Explore the Renault Trucks Traffic range



Key standard features of the Renault Trucks Traffic Red EDITION

EXTERIOR

- Chrome grille
- Half-painted front bumper
- Body-coloured rail covers and light mounts
- Foldable mirrors
- Automatic LED low beams
- Automatic windscreen wipers

SAFETY

- Cruise control & speed limiter
- Intelligent Speed Assistance (ISA)
- E-Call emergency services
- Front driver & passenger airbags
- Rear parking sensors
- AEBS with pedestrian & cyclist detection
- Drowsiness Driver Alert
- Lane Keeping Assistance (LKA)
- Tire Pressure Monitoring System

INTERIOR

- Closed glove compartment
- Wireless smartphone charger
- Carbon fabric upholstery
- Manual air-conditioning
- Cruise control with downhill braking + speed limiter
- Radio Display 8" with wireless smartphone replication
- Front and rear interior LED lighting
- Manual Air Conditioning
- Primary color display 3"5



Red
E D I T I O N

Renault Trucks Trafic Red EDITION Exclusive a premium finish

Optional extras to add to the standard Red EDITION to provide a premium experience, available on both Diesel and electric versions.

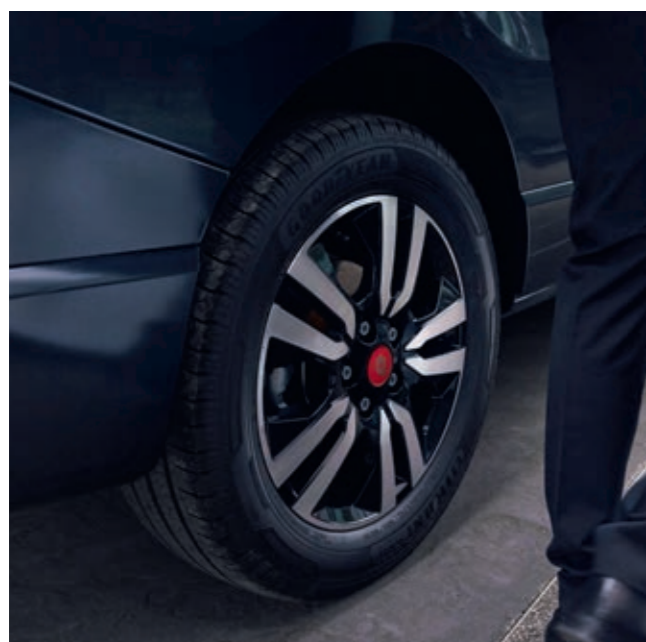

Key standard features of the Renault Trucks Trafic Red EDITION Exclusive

In addition to Red EDITION version content

AN EXCLUSIVE EXTERIOR DESIGN

- Full painted vehicle body
- Dark grey aluminium wheels with red insert
- Aluminium rear step protection
- Front fog and cornering lights
- 5 colours, including 4 metallic
- Red EDITION Exclusive stickers

ENHANCED DRIVING COMFORT

- Driver's seat with lumbar adjustment and armrest
- Foldable passenger bunk 2 seats with storage and table
- Closed upper dashboard storage & aluminium brushed dashboard finishing
- Digital 7" colour main display
- Keyless system with start button
- Automatic A/C
- Navigation display 8" with wireless smartphone replication
- Automatic switch low/high beams

Red
Rd
E D I T I O N



Peace of mind for your business

Renault Trucks is the perfect time-saving partner for your business: fast and efficient servicing, extended opening hours and 24/7 assistance including towing. Optimise your vehicle's uptime by maintaining its full potential.



Experts at your side

You can rely on a whole network of Renault Trucks professionals. With almost 1400 service points across Europe, there will always be a dealer near you.

Fast & professional space devoted exclusively to commercial vehicles:

- Expert and trained technicians
- Extended opening hours, including Saturday mornings*
- Fast appointments for repairs and maintenance

*May vary by dealership.



Quality parts and reliable service for peace of mind at work



Warranty covering parts and labour

2-year parts, breakdown and towing warranty for all operations carried out at an approved Renault Trucks repairer.



Genuine parts

Maintain your vehicle with Renault Trucks Genuine parts in order to maximize uptime and performance whilst reducing the maintenance costs over the long term. For a lower environment footprint, Renault Trucks also offers a full range of top quality remanufactured products.



24/7 breakdown service

A network of experts ready to assist you in 18 languages, to secure breakdown interventions and guarantee a high quality of service 7 days a week, 24 hours a day. In the event of a breakdown, a call to the 24/7 platform will trigger the intervention of a qualified technician. He will immediately carry out a pre-diagnosis, as per our commitment to limit the downtime of your Renault Trucks vehicle. Extend the standard assistance with Towing for Electric option. Towing for Electric includes unlimited number of tows for breakdown and two free tows in the event of battery discharge unrelated to product defect (within the 2 first years of the service contract)



Keep costs down with our tailor-made packages

Maintenance packages

Our prices are fixed in advance and repairs are carried out using original parts to guarantee the performance of your work vehicles.

Maintenance contract packages

START & DRIVE PACKAGE

REFERENCE	PERFORMANCE		EXCELLENCE
	STANDARD	MAXI	
			OPTION
OPTION	OPTION	OPTION	WEAR PARTS
	REPAIRS (driveline only)	REPAIRS (complete vehicle)	REPAIRS (complete vehicle)
PREVENTIVE MAINTENANCE	PREVENTIVE MAINTENANCE	PREVENTIVE MAINTENANCE	PREVENTIVE MAINTENANCE



All-in-one financing

Renault Trucks Financial Services offers a number of financing plans (hire purchase, lease solutions or contract Hire), as well as tailor-made insurance products*. Our all-in-one package gives you complete control over your total cost of ownership - with no nasty surprises.

*available depending on the country

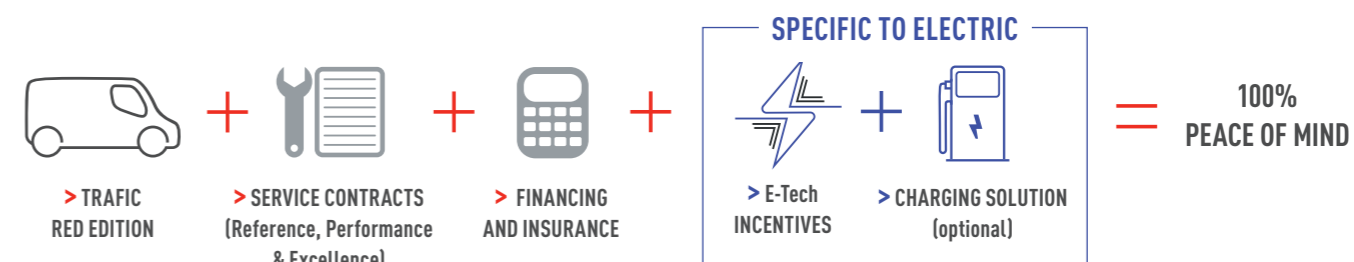

OPTIMIZED COSTS

- Up to 20%* discount (parts & labor)
- Fixed cost, with a smooth monitoring
- Increased residual value thanks to service contract

UPTIME

- Wide opening hours
- Scheduled maintenance
- Limited downtime

PEACE OF MIND

- Technicians's expertise
- 24/7 and towing included**
- Lower risks & less administration

PRODUCTIVITY (E-TECH)

- Diagnosis of usage & personalized recommendations
- Selection, installation & maintenance of private charging solutions
- Smart EV routing & business card to charge at the public charging station network
- Consumption monitoring through a supervision software & centralization monthly rebilling

*To be adapted locally
 **Electric towing is an option within the 2 first years of a service contract

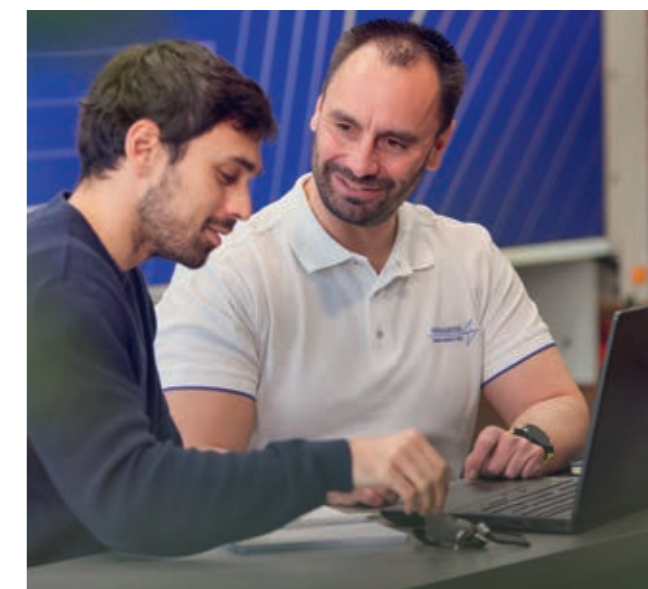

Optimise your fuel consumption

A dCi engine and driving aids to reduce emissions.



STOP & START SYSTEM

standard on all engines.



DRIVE MODE

standard on all models with manual transmission to reduce fuel consumption.



150 HP ENGINE

for lower fuel consumption and increased productivity.

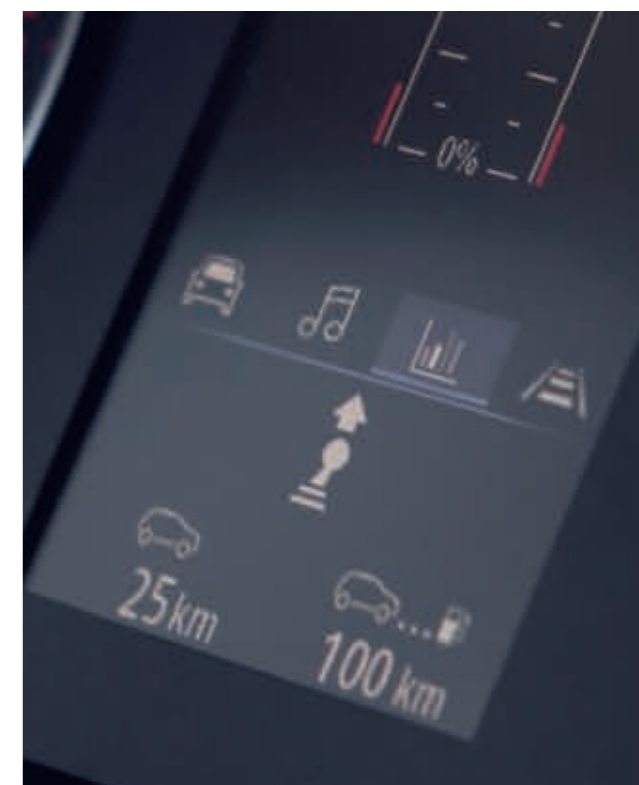

GEARSHIFT ASSISTANCE

to optimise fuel consumption.



Full electric to access restricted areas

Perfectly suited to assignments involving last mile deliveries, whether in staggered hours or urban areas with traffic restrictions, Renault Trucks E-Tech Traffic delivers the goods.



→ **6 VERSIONS**

- 2 heights (the H2 : allows stand up in the van with 1.89m height inside)

→ **3 MODELS**

- Panel van
- Van crew
- Platform cab

→ **GVW**

- 3,07 tons

→ **BATTERY**

- 52 kWh
- Technology: Lithium-ion

→ **TOWING CAPACITY**

- Up to 920 kg

→ **ELECTRIC MOTOR**

- Max. power: 90 kW
- Max. torque: 245 Nm

→ **PAYLOAD**

- 1 160 kg



RESPONSIBLE PROCUREMENT

Audits are carried out from the supply chain to the cobalt mines. Batteries are assembled in Europe. Vehicles are assembled in France.



52 KWH BATTERY COVERED WITH 8 YEARS WARRANTY*

*Battery State of Health 66% guaranteed 8 years or 160 000km.



→ **REDUCED OPERATING COSTS**

Energy cost estimation: 22 kWh/100km WLTP cycle.



→ **ADAPTED RANGE**

Up to 394 kilometres WLTP in urban cycle*.

*or 297 kilometres on combined cycle



→ **NO SOUND NUISANCE**

for better integration in urban environments and greater driving experience.

Customised support for your electric vehicle

Rely on Renault Trucks E-Tech experts to get full support on all aspects of your transition to electric.

Total peace of mind with a certified Renault Trucks E-Tech network and maintenance contract

Start & Drive Excellence contract

PREVENTIVE MAINTENANCE
+
WEAR PARTS
+
REPAIR
+
24/7 ASSISTANCE AND TOWING FOR ELECTRIC OPTION*



*Towing for Electric includes unlimited number of tows for breakdown and two free tows in the event of battery discharge unrelated to product defect (within the 2 first years of the service contract)



Dedicated charging support

Renault Trucks has selected partners to support you in all types of charging: at home, at work or on the road on public charging network.

Home & depot charging

Get an end-to-end support to choose, install, supervise & maintain the right charging infrastructure according to your daily operation:

- A diagnosis to define your needs (energy, charging stations, infrastructure...) with personalized recommendations to match your profile
- On site or virtual installation location check
- Transparent and fair installation offer with no hidden costs
- Fast and reliable installation by certified electrician
- Monitoring of your charging stations
- User assistance and maintenance

Public charging with Mobilize Power Solutions*: charge everywhere, plan your journey with the route planner and get preferred prices with your Renault Trucks Red EDITION card.

Benefit from a fleet management platform for direct billing and fleet monitoring.

*To be adapted locally.

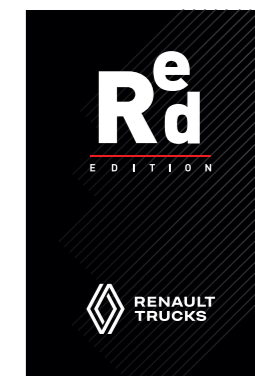

Ready for all your challenges

Renault Trucks can offer a vehicle configuration tailored to your business.



Interior customisation

You can organise the interior of your commercial vehicle to suit your business needs. Everything in its own place!

Carefully-designed interior:

- Hatch under bench seat
- Bench seat with storage
- Internal ladder rack

Complete your equipments with our packs

STORAGE PACK*

- Foldable passenger bunk with storage
- Rear panel with front access
- Sliding glove box
- Upper dashboard storage

DRIVER ASSIST PACK*

- Front fog lamps
- Automatic wipers
- Automatic low/high beams

DELIVERY PACK

- 270° rear panel doors
- Lateral rear anchorages
- Rear 12V socket
- Rear left door lock

PARK ASSIST PACK

- Rear camera
- Front, rear & lateral parking sensors
- Blind Spot Warning
- Blind Spot mirror



Ready to go for all trades

Renault Trucks Trafic Red EDITION is available in a variety of models - van, van crew, platform cab or combi to meet the needs of your business. Using special equipment (engine power take-off, additional wiring unit and body adaptation unit), Renault Trucks makes it easy to transform your vehicle.



Suitable to many activities



TRACTION CAPACITY

→ Ability to tow up to 2.5 tons*

A COMBI MODEL FOR TRANSPORTING PASSENGERS

- Up to 9 people and their luggage
- Superb comfort for both driver and passengers

*with manual gearbox



Best payload of its category

With its cubic shape and modular structure, the Renault Trucks Traffic guarantees the best load length on the medium commercial vehicle market.

→ **MAXIMUM EFFECTIVE VOLUME**
8.9 m³

→ **MAXIMUM EFFECTIVE HEIGHT**
1.9 m

→ **MAXIMUM EFFECTIVE LENGTH**
4.15 m

→ **LOW LOADING SILL HEIGHT**
(511 mm)

→ **PAYLOAD**
up to
1300 kg



→ **AN INTERIOR DESIGNED TO TRANSPORT YOUR EQUIPMENT SAFELY**

A latch on the left door* and side lashing hooks to safely transport long items.

*standard on H1 single cab models



Suitable to any environnement

With the Renault Trucks Trafic, you can meet your customers' every need at all times, in any environment!

HIGH-EFFICIENCY LOADING AND UNLOADING CAPABILITIES

- 180° or 270° rear doors
- Tail gate (optional)
- Twin side doors (optional)

PRACTICAL PARKING

- Ideal for parking in urban environments due to low roof height and compact dimensions



At ease on urban areas

REDUCED WIDTH AND HEIGHT

- Height: 1.97 m
- Width: 1.95 m

SMALL TURNING CIRCLE

- 6.2 m



On board comfort

You can even turn your cab into a functional and convenient mobile office.



Fold-down centre backrest provides a stable and convenient work surface



Folding bench seat



Induction charger for smartphones



Up to 88 litres of storage space



Navigation Display 8" with wireless smartphone replication



Refrigerated glove compartment

Everything within reach

In-cab controls are all situated within easy reach to deliver a high degree of driver usability. Driving aid systems and an automated gearbox allow the driver to concentrate on the task at hand.



1 Adaptive cruise control

2 Driver or driver and passenger airbag, optional side airbag

3 Digital 7" colour main display

4 Keyless starting system

5 Navigation Display 8" with wireless smartphone replication

6 Manual or regulated A/C

7 Induction charger for smartphones

8 Dual-clutch automated gearbox
(on 150 and 170 hp models)

Driving comfort

A driver's cab designed to provide a good field of vision in built-up areas.

- 1 LARGE WINDSCREEN
- 2 LED HEADLAMPS
- 3 6-SPEED ROBOTIZED GEARBOX
- 4 SUN SHADE WITH WIDE-VIEW MIRROR



Drive with total safety

Renault Trucks Trafic Red EDITION works alongside you on each trip by using technology to enhance your safety.



Driver assistance technology and different braking systems protect people and cargo. Various items of equipment and accessories further enhance driver safety.

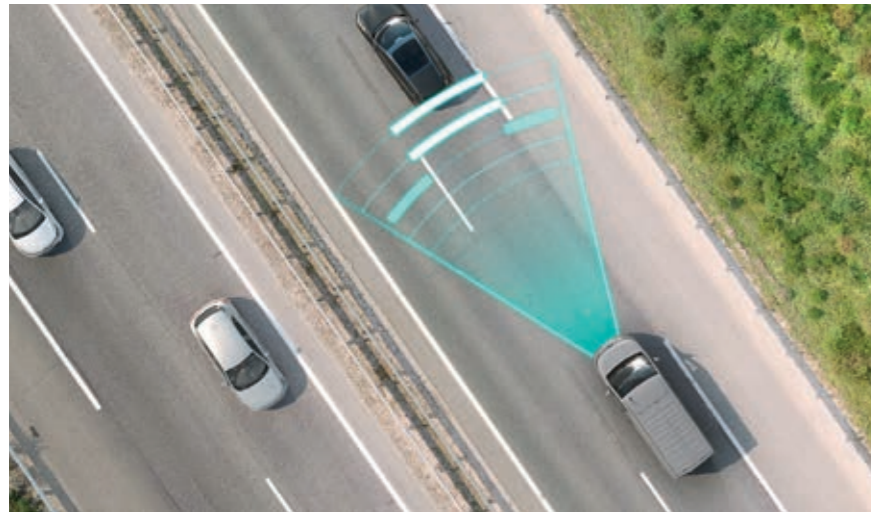

→ **ADAPTATIVE CRUISE CONTROL**

to help vehicles maintain a safe following distance and automatically adjusts the speed of the vehicle below the set one.



→ **RADARS AND REAR CAMERA**

Indicate the driver the presence of a vulnerable road user when reversing



→ **LANE DEPARTURE WARNING**

Audible warning signal alerts the driver of unintentional drifting from the vehicle's trajectory.



→ **EXTENDED GRIP**

Electronic management for all types of terrain (sand, snow, mud, etc.), is available as standard on all range.



→ **HILL START ASSIST**

The brakes are held for a few seconds after releasing the pedal to make hill starts easier.

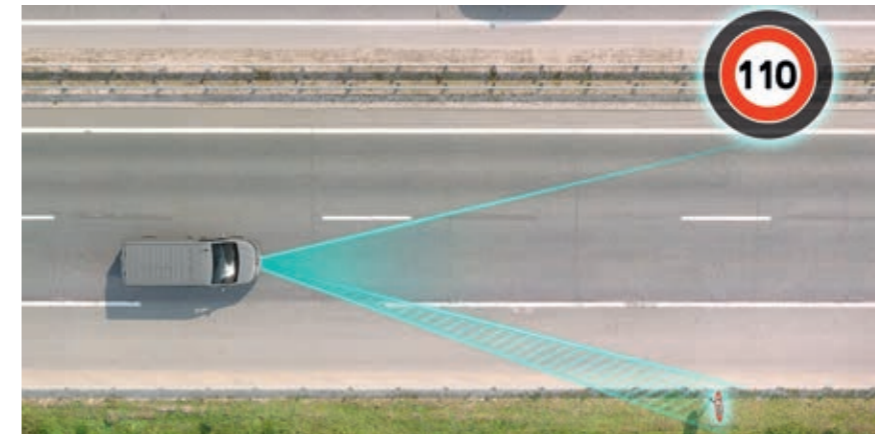

→ **INTELLIGENT SPEED ADAPTATION**

To recognize traffic signs and keeping the driver informed of speed limit changes and other important road information.



→ **BLIND SPOT WARNING**

The driver is warned of hazards in the blind spot using a light signal in the wing mirrors.



→ **DRIVER DROWSINESS DETECTION**

Prevent accident due to loss of attention. Improve driving comfort by minizing risks due to excessive fatigue.



→ **CROSSWIND ASSISTANCE**

This system helps the driver to stay in lane when experiencing crosswind.

Technical specifications

VARIOUS MODELS

→ L1H1 VAN



→ L2H1 VAN CREW



→ L2H1 VAN



→ L2H1 COMBI (available on diesel only)



→ L2H2 VAN



→ L2 PLATFORM CAB



COLOURS

SOLID LACQUER COLOURS



Glacier White*



Urban Grey



Cumulus Blue

METALLIC COLOURS



Highland Grey*



Comet Grey*



Carmin Red*



Midnight Black*

*Colors available for Red EDITION Exclusive version

Finishes

Red EDITION



UPHOLSTERY

Carbon grey fabric

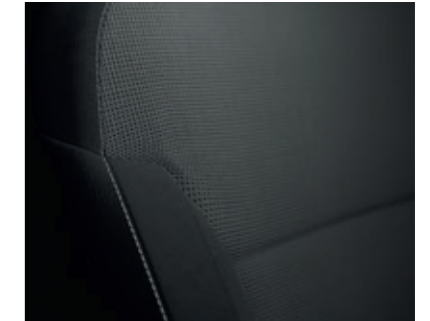

EXTERIOR DESIGN

Chrome radiator grille - Half-painted front bumper, body-coloured side hatch rail and light mounts



WHEEL RIMS

Metal 16" - standard hub casing



Red EDITION Exclusive



UPHOLSTERY

Black geometric fabric

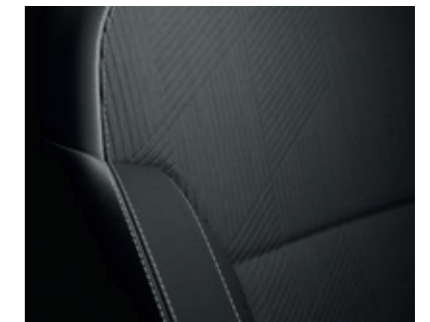

EXTERIOR DESIGN

Chrome radiator grille - semi-painted front bumper, body-coloured side hatch rail, light mounts, side guards, rear bumper and mirrors, Red EDITION stickers



WHEEL RIMS

Aluminium 17" - Dark grey



Accessories



Towing hook



Roof rack solutions



Red EDITION seats covers



Specific Renault Trucks wood trimming



Red EDITION floor mat

Range overview

	Van		Van crew		Platform cab	9-seater Combi
	L1H1 L2H1	L1H2 L2H2	L1H1 L2H1	L1H1 L2H1	L2	L1H1 L2H1
Equipment level	Red Edition Red Edition EXCLUSIVE		Red Edition Red Edition EXCLUSIVE		Red Edition	Red Edition
Manual gearbox engine	110 hp 130 hp 150 hp 170 hp		150 hp 170 hp		150 hp 170 hp	150 hp
Automated dual clutch engines	150 hp 170 hp		-		-	150 hp 170 hp
GCW	L1H1 : 3T L2H1 : 3T1		3T		3T	2T8

Power train

	110 hp Stop & Start	130 hp Stop & Start	150 hp Stop & Start	170 hp Stop & Start
Engine capacity	4 cylinders / 2.0 L / Single Turbo			
Maximum power at 3500 rpm	81 kW	96 kW	110 kW	125 kW
Maximum torque at 1500 rpm	300 Nm	320 Nm	350 Nm	380 Nm
Type of injection	Common Rail Direct Injection (2500 bar)			
Tank Capacity (Fuel / AdBlue)	80 L / 24.7 L			
Transmission	Manual 6-speed		Manual 6-speed / 6-Speed robotized dual clutch	
Standard	EURO 6 E-FULL			
Cycle	WLTP (Worldwide harmonized Light vehicles Test Procedures)			
Fuels compliant with European standards with which the engines of vehicles sold in Europe are compatible	B7 : EN590 compliant fuel containing up to 7% fatty acid methyl esters by volume B10 : EN16734 compliant fuel containing up to 10% fatty acid methyl esters by volume XTL : EN15940 compliant paraffinic diesel fuel containing up to 7% fatty acid methyl esters by volume			

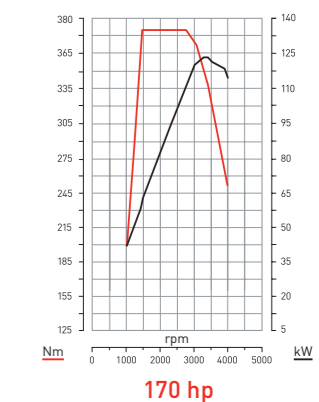
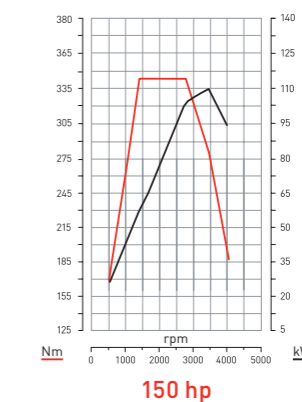
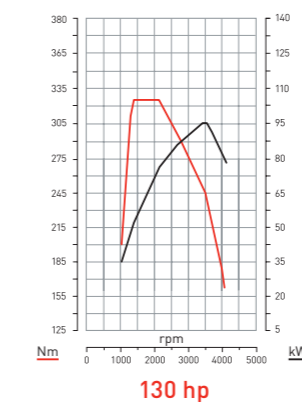
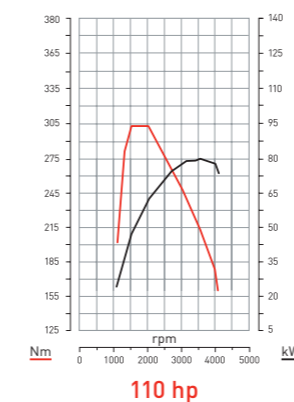

E-Tech (Electric version)

	Panel Van			Van crew		Platform
	L1H1	L2H1	L2H2	L1H1	L3H1	L2
GVW	3.07 Tons					
Payload	1.16 Tons					
Load volume	5.8 m ³	7.75 m ³	8.9 m ³	3.36 m ³	4 m ³	-
Battery	52 kWh / 400V / 332 kg / 48 modules / 192 cells					
Maximum speed	110 km/h or 90 km/h					
Motor type	R120 / Max Power : 90kW - 120 hp / Max Torque : 245 Nm					

Weights and dimensions

Van / Van crew

FRONT-WHEEL DRIVE	Van				Van crew	
	L1H1	L1H2	L2H1	L2H2	L1H1	L2H1
GCW	3 t	3 t	3.1 t	3 t	3 t	3 t
External dimensions						
Overall length	5080 mm		5480 mm		5080 mm	5480 mm
Long overhang	1014 mm					
Wheelbase	3098 mm		3498 mm		3098 mm	3498 mm
Rear overhang	968 mm					
Overall width / with wing mirrors	1956 / 2283 mm					
Total height	1971 mm	2495 mm	1967 mm	2498 mm	1971 mm	1967 mm
Turning circle, kerb-to-kerb / wall-to-wall	6.2 / 6.4 m		6.9 / 7.18 m		6.2 / 6.4 m / 6.9 / 7.18 m	
Min. ground clearance	160 mm					
Weight and loads						
Max. load on front axle	1625 kg					
Max. load on rear axle	1650 kg					
Maximum towable mass (unbraked / braked) manual gearbox	750 / 2500 kg					
Maximum towable mass (unbraked / braked) 6-Speed robotized	750 / 1680 kg	-	750 / 1680 kg	-	750 / 1680 kg	750 / 1680 kg
Loading area (mm)						
Effective volume	5.8 m ³	6.7 m ³	7.75 m ³	8.9 m ³	3.36 m ³	4.3 m ³
Width x length of bulkhead hatch	510 X 222 mm				-	
Internal effective length / to 1m	2537 mm		2937 mm		2023 / 1340 mm	2423 / 1740 mm
Internal effective floor length including under-seat area / footwell	2950 / 3750 mm		3350 / 4150 mm		-	
Effective height	1387 mm	1898 mm	1387 mm	1898 mm	1387 mm	
Internal effective width	1662 mm					
Width between wheel arches	1268 mm					
Sliding side hatch(es)						
Height	1284 mm					
Width to 100 mm / 600 mm	1030 / 907 mm					
Rear doors						
Height	1320 mm	1820 mm	1320 mm	1820 mm	1320 mm	1820 mm
Width (to 70 mm)	1391 mm					
Loading sill	552 mm					

Cabs

VAN

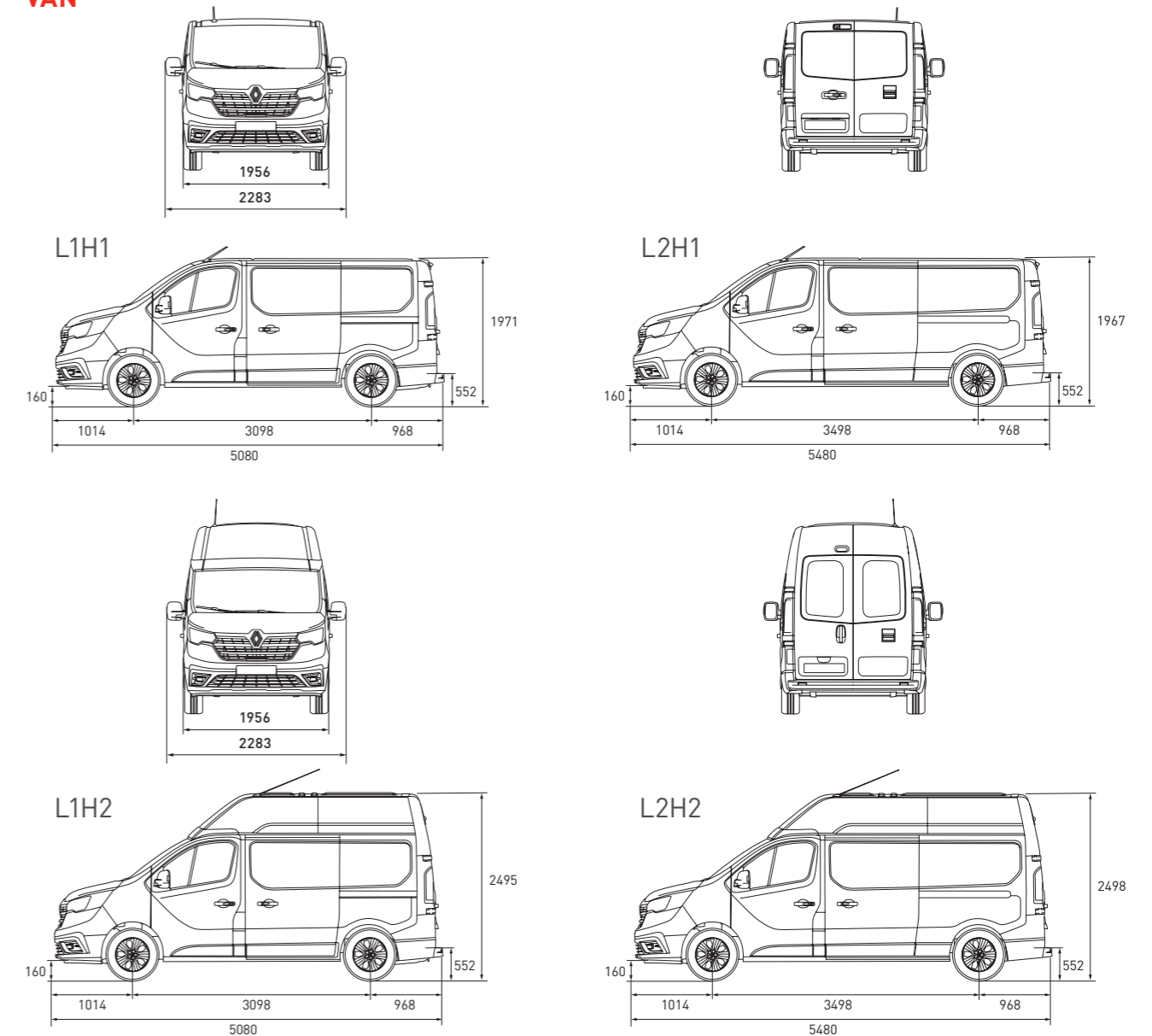

VAN CREW

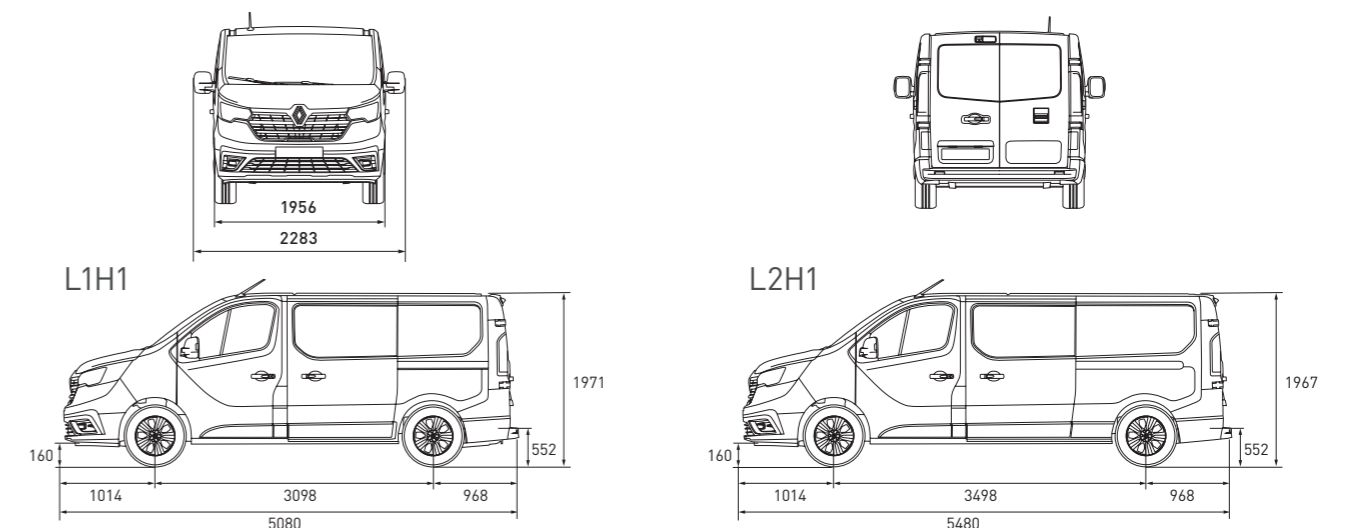

Weights and dimensions

Platform cab / 9-seater Combi

(available on diesel version only)

	Platform Cab	9-seater Combi	
FRONT-WHEEL DRIVE	L2	L1H1	L2H1
GCW	3 t	3 t	3 t
External dimensions			
Overall length	5248 mm	5080 mm	5480 mm
Long overhang	1014 mm		
Wheelbase	3498 mm	3098 mm	3498 mm
Rear overhang	817 mm	968 mm	
Overall width / with wing mirrors	1956 / 2283 mm	1956 / 2283 mm	
Total height	1967 mm	1971 mm	1967 mm
Turning circle, kerb-to-kerb / wall-to-wall	6.9 m / depending on body	6.2 / 6.4 m	6.9 / 7.18 m
Min. ground clearance	160 mm	160 mm	
Weight and loads			
Max. load on front axle	1585 kg	1625 kg	
Max. load on rear axle	1650 kg	1650 kg	
Maximum towable mass (unbraked / braked) manual gearbox	750 / 2000 kg	750 / 2500 kg	
Maximum towable mass (unbraked / braked) 6-Speed robotized	-	750 / 1680 kg	750 / 1680 kg
Effective volume			
8-9 seater model	-	1 m ³	1.8 m ³
3rd row folded down / removed	-	2.5 / 3.2 m ³	3.4 / 4.1 m ³
2nd row folded down / removed	-	4.7 / 5.2 m ³	5.7 / 6.0 m ³
Internal dimensions			
Loading length in 8-9 seater version	-	736 mm	1136 mm
Loading length 3rd row folded down / removed	-	1152 / 1650 mm	1552 / 2050 mm
Loading length 2nd row folded down / removed	-	2066 / 2537 mm	2466 / 2937 mm
Effective height	-	1369 mm	
Maximum internal width	-	1662 mm	
Width between wheel arches	-	1268 mm	
Sliding side hatch(es)			
Height	-	1284 mm	
Width to 100 mm / 600 mm	-	1030 / 907 mm	
Rear opening (mm)			
Door height 180° / tailgate	-	1320 / 1295 mm	
Width (to 70 mm)	-	1391 mm	
Loading sill	-	552 mm	

Cabs

PLATFORM CAB

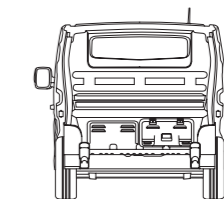
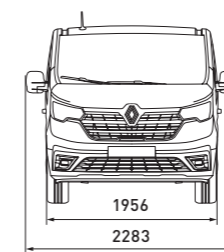

L2

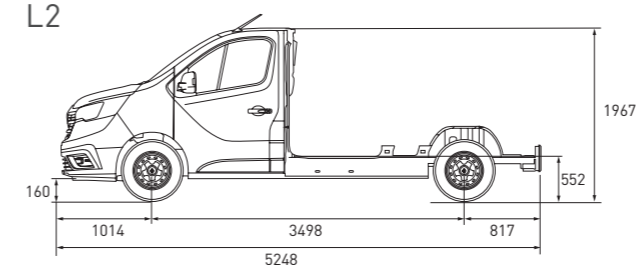

9-SEATER COMBI (available on diesel version only)

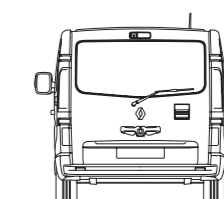
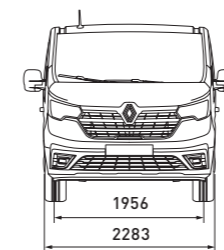

L1H1

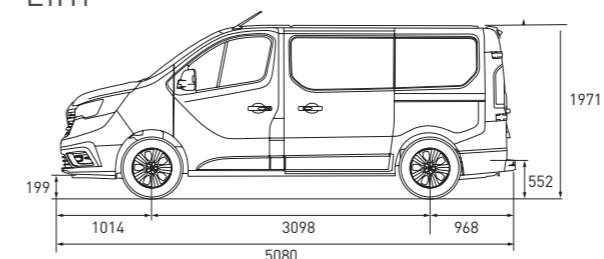

L2H1

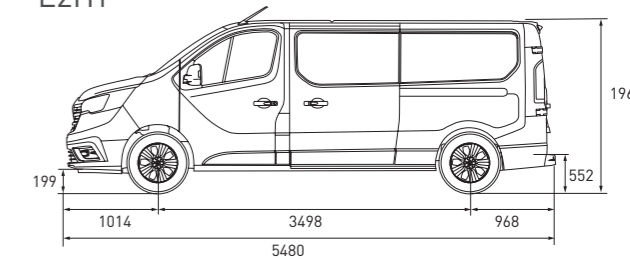



01/2024

We recommend Renault Trucks Oils.
Dimensions and characteristics are only indicative.
The manufacturer reserves the right to modify them without notice.
Renault Trucks SAS with a capital of € 50,000,000 - 954 506 077 RCS
Non contractual photos



**RENAULT
TRUCKS**